

Bioinspired artificial fingertips that exhibit friction reduction when subjected to transverse ultrasonic vibrations

Rebecca Fenton Friesen^{*1}, Michaël Wiertelowski^{1,2}, Michael A. Peshkin¹ and J. Edward Colgate¹

Abstract—This paper presents the design of a bioinspired artificial fingertip that resembles the mechanical behavior of a human fingertip under conditions of both static deformation and high frequency excitation. The artificial fingertip is constructed around a deformable spherical membrane filled with a cellulose sponge, itself connected to a rigid structure that acts as a bone. Force-displacement characteristics and response to a transient mechanical perturbation are both shown to be in good qualitative agreement with those of a real finger. More importantly, the fingertip exhibits friction reduction when interacting with TPads (variable friction tactile displays based on transverse ultrasonic vibrations). Comparison with artificial fingertips that do not exhibit friction reduction suggests that mechanical damping characteristics play a key role in the amount of friction reduction achieved.

I. INTRODUCTION

Ultrasonic vibration of a flat touch panel, such as the TPad [1], [2], [3], creates a sizable reduction of the friction that a finger experiences while sliding across the surface. This phenomenon can be modulated as a function of finger position and velocity to create a wide variety of artificial sensations, such as rough and smooth textures or even 3-dimensional perceptions of gratings and bumps. However, the mechanisms behind this method of friction reduction are not well understood, and several competing theories exist. The prevailing theory relies on the squeeze-film effect: at sufficiently high frequency and amplitude air is pumped and captured between the finger and oscillating plate. This cushion of air acts like a spring, supporting part of the normal load [1], [4]. However, an alternative theory suggests that friction reduction could be due to the finger bouncing off the plate and undergoing intermittent contact [5], [6]. As the time of contact becomes shorter, the friction force is decreased. A deeper understanding of this phenomenon, in terms of the role of played by the air, the influence of the panel dynamics, as well as the contributions of the underlying fingertip structure, is crucial to better designing surface-haptic interfaces. Towards this goal, we created a series of artificial fingers whose mechanical structure mimics the arrangement of tissues found in human fingertips. The frictional properties of each artificial fingertip were measured and compared against both a commercially available artificial finger and a human fingertip. An artificial finger that mimics the frictional properties of human fingers would be a useful proxy in future experiments, and behavioral differences

between artificial fingers of similar construction can help elucidate the important features of the finger interacting with a surface excited with ultrasonic transverse waves.

A. Advantages of a Mechanical Model

Artificial fingertips have the advantage of replaceable parts; components can be replaced with those of different material properties or shapes, helping narrow down the features that contribute to particular behaviors. Additionally, they withstand long and repetitive tribological experiments, and can be placed under potentially extreme conditions such vacuum or heat. For example, investigating the effects of low air pressure on the postulated squeeze-film effect would require a finger that could withstand vacuum conditions. An easily reproducible artificial finger can also help standardize experiments and procedures that are difficult to perform due to the variability and delicacy of human subjects' fingers.

B. Mechanical Properties of Human Fingers

The human finger is composed of multiple highly differentiated tissues that provide remarkable toughness and resilience. The glabrous skin that covers the fingertip is highly compliant and conforms to a large set of surfaces while maintaining high friction when in contact with a wide range of materials [7], [8], [9]. The structure of the skin, based upon a series of layers, is likely to be responsible for these unique properties. The superficial tissues of the epidermis are made of stiff corneocytes arranged in a corrugated structure that provides the high deformability. This structure is supported by subcutaneous tissues composed of a collagen fiber network filled with fatty liquid providing a compliant and viscous support to the outer layers of skin [10], [11], as illustrated in Fig. 1a.

In bulk, the fingertip pulp behaves as a viscoelastic nonlinear spring-mass-damper system in the lateral and normal directions. The large damping ratio dominates dynamics above 100 Hz, causing the skin to experience significant damping of high frequency wave propagation [12], [13], [14], [15], [16]. Bulk deformation patterns suggest that the heterogeneous structure of the finger plays an important role in how the finger reacts to loads. With a heterogeneous finite element model, Srinivasan demonstrated that a finger composed of a flexible membrane enclosing an incompressible fluid closely tracks experimental surface deformation shape under a line load [9]. Conversely, an elastic homogeneous model has a markedly different surface deflection profile. Serina et al. expanded on these results to show that the heterogeneous model also displays the nonlinear force versus displacement

^{*}corresponding author r-friesen@northwestern.edu

¹ Department of Mechanical Engineering, Northwestern University, Evanston, IL, USA

²Aix-Marseille Université, CNRS, UMR 7287 ISM, 13288 Marseille, France

relationship expected with a human fingertip during normal contact with a flat surface [17].

C. Previous Implementations of Artificial Fingertips

Han and Kawamura [18] built an early heterogeneous physical model of a finger, which consisted of a stiff silicone rubber membrane, aluminum bone core, and softer silicone inner filling. They demonstrated similar deformation properties between their artificial construction and human fingers, including both nonlinear force versus normal displacement and linear contact area versus normal displacement curves.

More recently, Shao et al. built both physical and computational models of the fingertip in order to model not only quasi-static deformation but also sliding frictional properties [19]. Their physical models also used the previously described heterogeneous construction, with a skin, soft tissue and bone layer constructed of silicone and acrylic materials, along with two new features; they include a thin layer of acrylic on the surface of the rubber membrane, and modified the tissue filling to create two contrasting models. One model was composed of a purely elastic soft silicone rubber, and the other contained a combination of both silicone rubber and gel that exhibited viscoelastic properties. Both models reproduced the force versus displacement relationships of human fingers, and the latter also exhibited the hysteresis present in human fingers during loading and unloading. These models outperformed a pure silicone rubber finger in exhibiting frictional forces similar to a human finger on a variety of surfaces, including steel, cardboard, and plastic.

Many existing commercially available artificial fingers aim to provide mechanical measurements of the deformation of the skin in order to provide robotic hands an estimation of the contact condition and facilitate the control of object manipulation. The reader can refer to [20], [21] for literature reviews on tactile sensing. In that regard they usually optimize their material properties for robustness of repetitive tasks and do not strive to have a mechanical behavior close to that of a human fingertip. This article compares two mechanically accurate models to a commercially available artificial fingertip (BioTac, Syntouch llc, Los Angeles, CA, USA) [22], and a human fingertip. The BioTac was chosen because it has human-like sensing capabilities, yet does not exhibit strong friction reduction on an ultrasonically vibrating glass plate, in contrast to a human finger.

II. MATERIALS AND METHODS

A. Artificial Fingertip Construction

The two fingers built for this experiment consist of a core block of aluminum, a very soft sponge filling to simulate tissue, a stiffer outer shell membrane to simulate skin, and an outermost thin layer of textured acrylic paint, see Fig. 1b. The outer paint layer simulates the stiff stratum corneum of the outer skin, and both provides a consistent outer surface when varying skin shell materials and reduces the coefficient of friction to a level similar to that of a dry human finger. This layer was applied in a textured pattern in order to approximate the human finger's actual area of contact, which

is a fraction of apparent total area due to fingerprint ridges (see Fig. 3). In addition to being extremely soft, the sponge filling resembles tissue in its slight time lag when recovering from a deformation; like the fingers constructed by Shao et al. [19], these fingers exhibit some degree of hysteresis. Two types of membrane were tested, both with shore A hardness 20 and 1 mm thick. The membrane is a hollow cylinder closed by a 10 mm radius hemispheric cap. The first type was molded Dragon Skin rubber (SmoothOn Inc, Easton PA, USA) which was highly stretchy and elastic, and the second was a 3D printed shell of TangoPlus (Stratasys Ltd., Rehovot, Israel), a rubber-like material which behaved more viscoelastically in response to deformation. These fingers will subsequently be referred to as the Dragon Skin finger and TangoPlus finger, respectively.

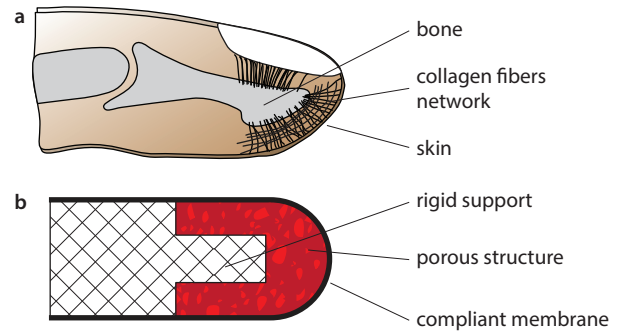

Fig. 1. a. Structure of the fingertip. The skin is connected to the bone via a network of collagen fibers. b. The construction of each artificial fingertip mimics the structure of the human fingertip.



Fig. 2. Size and shape of artificial fingers alongside the human finger used for comparison. Shown from left to right are the TangoPlus, Dragon Skin, BioTac, and human fingers.

B. Slow Deformation and Friction Force Measurements

As illustrated in Fig. 4, the experimental setup used for slow deformation and friction measurements consists of a glass plate mounted in a frame attached to a 6 axis load cell (Nano17, ATI Industrial Automation Inc., Apex, NC, USA). The apparatus can move on a linear slider tangentially to the fingertip surface, and the finger can move perpendicular to the glass on another slider. Fingers are mounted at an angle of 45 degrees normal to the glass surface. During quasi-static experiments, the finger platform moves towards and then away from the glass plate at a speed of 1 mm/s. For friction measurements, the finger is fixed to a position for

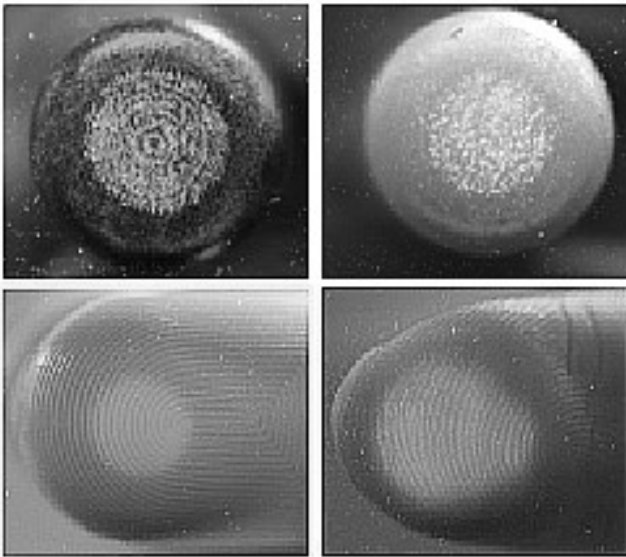

Fig. 3. Fingers' actual area of contact with glass illuminated via frustrated total internal reflection (FTIR). Shown clockwise from top left are the TangoPlus, Dragon Skin, human, and BioTac fingers.

which the normal force is 0.5 N and the plate is moved back and forth against the surface of the finger at a speed of 1 cm/s using a servo-controlled linear stage.

During friction sliding experiments, the glass is vibrated in the direction normal to the finger at a frequency of 32.112 kHz using a ± 200 V signal sent to piezoelectric actuators glued to the glass. This frequency corresponds to the resonant frequency of the glass plate which maximizes transverse displacement of the surface reaching $\pm 2.1 \mu\text{m}$. Vibration amplitude is monitored during experiments with another piezoelectric actuator to ensure that differences in friction levels are not due to damping of the amplitude.

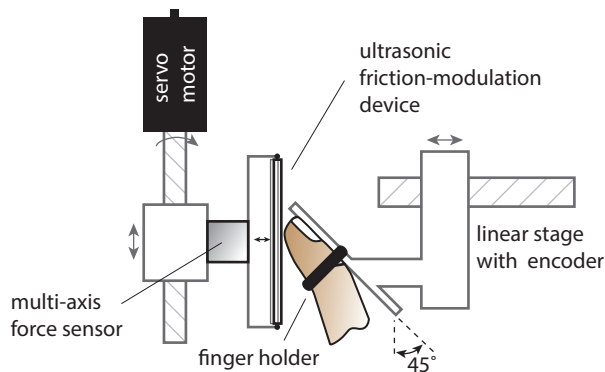

Fig. 4. Friction force measurement setup. Fingers are fastened to a manually moving linear stage. The glass plate provides transverse ultrasonic vibration, and is mounted on a servo-controlled linear stage. Interaction forces are measured by a force sensors.

C. Impact Restitution Measurement

As the friction reduction effect is likely to involve short transient with large relative velocities, an experiment was performed to measure dynamic behavior of each fingertip

under similar conditions. For this purpose, a second experimental setup, shown Fig. 5, was constructed. A 15 g weight was dropped down a linear guide to strike the finger at a speed of approximately 35 cm/s, on the order of magnitude of the speed at which the vibrating plate moves in the friction reduction experiments [23]. The position of the weight was tracked via a high-speed camera (EX-F1, Casio, Tokyo, Japan) recording at 600 fps and calibrated against a ruler. The coefficient of restitution was calculated from the ratio of velocities before and after the initial impact.

III. RESULTS

A. Slow Deformation Experiment

Under slow deformation, the human fingertip exhibits a highly non-linear hysteretic relationship between deformation and resulting normal force, as shown in figure 5. In contrast, the stiffer BioTac finger exhibits a relatively linear force displacement curve with little dissipation. The TangoPlus and Dragon Skin fingers exhibit quasi-static behavior somewhere in-between. While still slightly stiffer than the human fingertip, they exhibit a similar degree of hysteresis, and unloading resembles the hysteretic force-displacement relationship observed in human fingers [12].

B. Fast Deformation Experiment

Under faster impacts, two different types of behavior are observed, see Fig. 7. Both the BioTac and Dragon Skin fingertips cause the weight to bounce upon impact and to settle after approximately three collisions. Conversely, the impact on human and TangoPlus fingertips is attenuated and little rebound is observed. When the weight hits these fingers it stops abruptly.

C. Friction Reduction Experiment

To explore the effects of plate vibration on the friction properties, the friction coefficient was measured for all four fingers sliding on the glass plate, with and without vibrating the glass. Significant decreases in the friction coefficient were observed for both the human and TangoPlus finger, while the Dragon Skin and BioTac finger exhibited negligible changes. The coefficient of friction values are shown in Fig. 8.

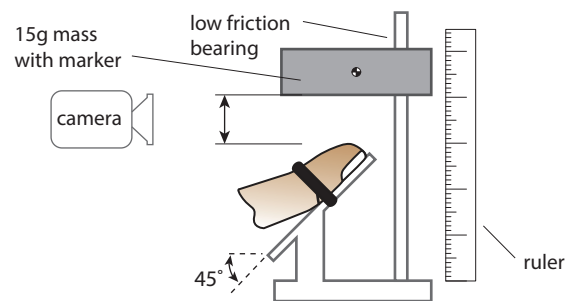

Fig. 5. Impact restitution experiment. The position of the mass impacting the finger is measured via a high speed camera.

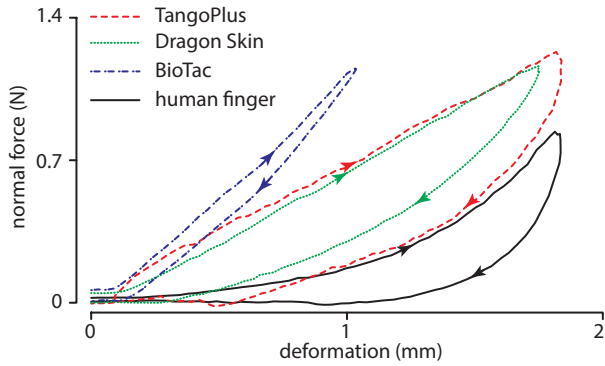

Fig. 6. Quasi-static response of each finger. Each shows different stiffness and hysteresis behavior. Due to the same core components, the TangoPlus and Dragon Skin fingers behave similarly to a quasi-static deformation.

IV. DISCUSSION

Several past studies have shown that a heterogeneous construction of a fingertip model using the right combination of material properties closely approximates the deformation of a human finger, as well as friction properties when in contact with a non-vibrating surface. However, this low frequency behavior does not appear to be a good predictor of friction reduction properties observed when the plate is vibrating at ultrasonic frequency. The two artificial fingers constructed for this study had highly similar force displacement curves under slow deformation, yet exhibited markedly different trends in friction reduction. And even though the human finger and the TangoPlus finger did not have identical stiffnesses or shapes of their force displacement curves, they both experienced a significant reduction in friction while the other two fingers, with even more dissimilar force displacement curves, had a similar lack of friction reduction, see Fig. 7 and 8.

However, at speeds an order of magnitude faster than the quasi-static conditions, the deformation behavior of the TangoPlus and Dragon Skin fingers diverge and better predict their frictional properties. Both the BioTac and Dragon Skin fingers produce some bouncing in a weight dropped on them at higher speeds, while the TangoPlus and human finger

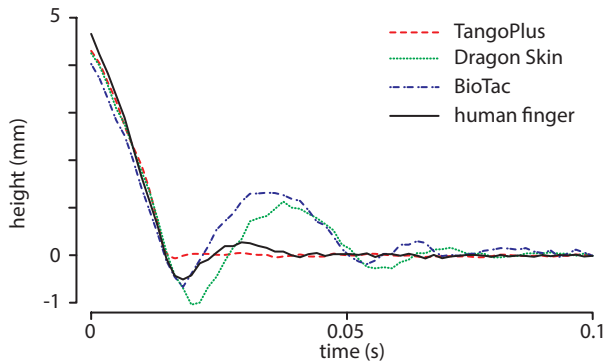

Fig. 7. Vertical position of the weight during collision for each finger. BioTac and Dragon Skin fingers show highest energy restitution after impact.

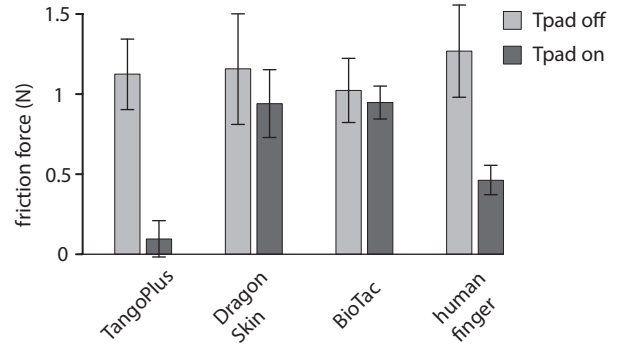

Fig. 8. Effect of ultrasonic vibration on the friction force experienced by each finger. The human and TangoPlus fingers show the highest reduction when transverse vibration has a large amplitude.

dissipate the impact from the first collision. These trends correlate well with the friction reduction effects on a TPad. The fingers that absorb impact also experienced higher friction reduction, while the more elastic fingers, i.e. the BioTac and Dragon Skin, exhibit almost no reduction of friction. Figure 9 highlights the relationship of impact dissipation to the effectiveness friction reduction via ultrasonic vibrations. In contrast, the stiffness measured in quasi-static conditions does not show any correlation to friction reduction.

These results suggest that while filling material necessarily affects slow deformation shape, it has a smaller impact on friction reduction. Skin material, conversely, played a large role in susceptibility to friction reduction; the TangoPlus and Dragon Skin fingers differed only in skin material properties and had the same thickness and durometer scale stiffness, yet exhibited markedly different friction reduction behavior.

Unsurprisingly, high speed impact behavior predicts behavior on a high speed vibrating plate better than slower deformation properties. Perhaps less intuitively, these predictions suggest that bouncier fingers are not as strongly affected by a transversely vibrating surface. An examination of how a finger might dynamically interact with a TPad offers a possible explanation of these results. Friction of skin against glass is known to be principally due to adhesion, and

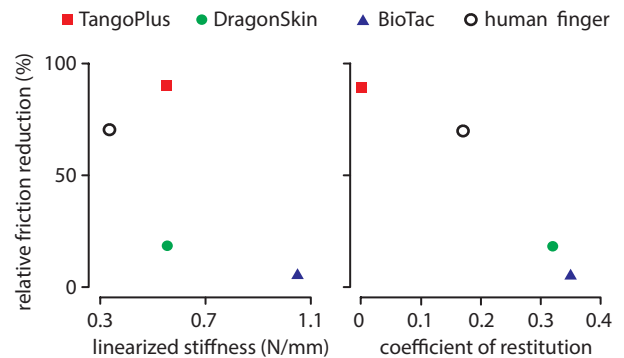

Fig. 9. Friction reduction effectiveness compared to quasi-static stiffness and coefficient of restitution of each finger. Relationship between coefficient of restitution and friction reduction power is monotonic for the sample of fingertips tested.

therefore to scale with true area of contact [24]. Accordingly, a TPad must, through some mechanism, reduce the time-averaged area of contact. While it has long been thought that a squeeze film of air is responsible for this reduction, the present results suggest a more nuanced picture. The pumping action that leads to formation of a squeeze film stems from rapid oscillation of the air gap (indeed, the classical theory [4] assumes that one surface is fixed while the other oscillates, ensuring oscillation of the gap itself). In the case of an elastic skin, it is probable that the skin can essentially track the vibrations of the surface itself, leading to a gap that does not oscillate. Added damping, however, slows the response of the skin, enabling an oscillating gap to develop. It is also important to understand that the motions of the TPad surface have extremely small amplitudes ($\approx 1\mu\text{m}$) so that elastic effects should be minimal, but rather large velocities ($\approx 20\text{ cm/sec}$) so that viscous damping effects are significant. Ongoing work in our lab is aimed at one, imaging the gap directly via frustrated total internal reflection (FTIR) techniques, and two, making measurements in various levels of vacuum. It is our belief that these measurements will lead to a more complete understanding of the friction reduction mechanism.

V. CONCLUSIONS

Two types of artificial fingers were built consisting of bone, tissue, skin, and outer skin layers. Both were tested for deformation properties and presence of friction reduction on a high frequency vibrating plate, and results were compared to a human fingertip and the BioTac finger. Changes in the elastic properties of the artificial skin had little effect on slow deformation, but large effects on both rapid deformation and friction reduction properties of the fingers. These results suggest that high speed viscoelastic properties of the shell of a heterogeneous artificial finger play a large role in the friction reduction observed with a TPad. Artificial finger skin with high damping provides a closer approximation of the frictional behavior of a human finger on a vibrating plate.

ACKNOWLEDGMENT

The authors would like to thank Professor Kevin Lynch for generously lending us a BioTac finger for measurements and Jeremy Fishel for his advice and consultation on BioTac properties. This work was supported by NSF Grant IIS-1302422.

REFERENCES

- [1] T. Watanabe and S. Fukui, "A method for controlling tactile sensation of surface roughness using ultrasonic vibration," in *Robotics and Automation, 1995. Proceedings., 1995 IEEE International Conference on*, vol. 1. IEEE, 1995, pp. 1134–1139.
- [2] L. Winfield, J. Glassmire, J. E. Colgate, and M. Peshkin, "T-pad: Tactile pattern display through variable friction reduction," in *EuroHaptics Conference, 2007 and Symposium on Haptic Interfaces for Virtual Environment and Teleoperator Systems. World Haptics 2007. Second Joint*. IEEE, 2007, pp. 421–426.
- [3] M. Biet, F. Giraud, and B. Lemaire-Semail, "Squeeze film effect for the design of an ultrasonic tactile plate," *Ultrasonics, Ferroelectrics and Frequency Control, IEEE Transactions on*, vol. 54, no. 12, pp. 2678–2688, 2007.

- [4] E. Salbu, "Compressible squeeze films and squeeze bearings," *Journal of Fluids Engineering*, vol. 86, no. 2, pp. 355–364, 1964.
- [5] X. Dai, J. E. Colgate, and M. A. Peshkin, "Lateralpad: A surface-haptic device that produces lateral forces on a bare finger," in *Haptics Symposium (HAPTICS), 2012 IEEE*. IEEE, 2012, pp. 7–14.
- [6] L. Winfield and J. E. Colgate, "Variable friction haptic displays," in *Haptic rendering: Foundations, algorithms and applications*, M. C. Lin and M. Otaduy, Eds. AK Peters, Ltd., 2008.
- [7] P. H. Warman and A. R. Ennos, "Fingerprints are unlikely to increase the friction of primate fingerpads," *Journal of Experimental Biology*, vol. 212, no. 13, pp. 2016–2022, 2009.
- [8] S. M. Pasumarty, S. A. Johnson, S. A. Watson, and M. J. Adams, "Friction of the human finger pad: influence of moisture, occlusion and velocity," *Tribology Letters*, vol. 44, no. 2, pp. 117–137, 2011.
- [9] M. A. Srinivasan, "Surface deflection of primate fingertip under line load," *Journal of biomechanics*, vol. 22, no. 4, pp. 343–349, 1989.
- [10] M. Shrewsbury and R. Johnson, "The fascia of the distal phalanx," *The Journal of Bone & Joint Surgery*, vol. 57, no. 6, pp. 784–788, 1975.
- [11] M. Murai, H.-K. Lau, B. P. Pereira, and R. W. Pho, "A cadaver study on volume and surface area of the fingertip," *The Journal of hand surgery*, vol. 22, no. 5, pp. 935–941, 1997.
- [12] D. T. Pawluk and R. D. Howe, "Dynamic lumped element response of the human fingerpad," *Journal of biomechanical engineering*, vol. 121, no. 2, pp. 178–183, 1999.
- [13] N. Nakazawa, R. Ikeura, and H. Inooka, "Characteristics of human fingertips in the shearing direction," *Biological cybernetics*, vol. 82, no. 3, pp. 207–214, 2000.
- [14] T. C. Pataky, M. L. Latash, and V. M. Zatsiorsky, "Viscoelastic response of the finger pad to incremental tangential displacements," *Journal of biomechanics*, vol. 38, no. 7, pp. 1441–1449, 2005.
- [15] M. Wiertelowski and V. Hayward, "Mechanical behavior of the fingertip in the range of frequencies and displacements relevant to touch," *Journal of biomechanics*, vol. 45, no. 11, pp. 1869–1874, 2012.
- [16] R. O. Potts, E. M. Buras, and D. A. Chrisman, "Changes with age in the moisture content of human skin," *Journal of investigative dermatology*, vol. 82, no. 1, pp. 97–100, 1984.
- [17] E. R. Serina, C. Mote Jr, and D. Rempel, "Force response of the fingertip pulp to repeated compression—effects of loading rate, loading angle and anthropometry," *Journal of biomechanics*, vol. 30, no. 10, pp. 1035–1040, 1997.
- [18] H.-Y. Han and S. Kawamura, "Analysis of stiffness of human fingertip and comparison with artificial fingers," in *Systems, Man, and Cybernetics, 1999. IEEE SMC'99 Conference Proceedings. 1999 IEEE International Conference on*, vol. 2. IEEE, 1999, pp. 800–805.
- [19] F. Shao, T. H. Childs, and B. Henson, "Developing an artificial fingertip with human friction properties," *Tribology international*, vol. 42, no. 11, pp. 1575–1581, 2009.
- [20] R. S. Dahiya, G. Metta, M. Valle, and G. Sandini, "Tactile sensing—from humans to humanoids," *Robotics, IEEE Transactions on*, vol. 26, no. 1, pp. 1–20, 2010.
- [21] H. Yousef, M. Boukallel, and K. Althoefer, "Tactile sensing for dexterous in-hand manipulation in robotics—a review," *Sensors and Actuators A: physical*, vol. 167, no. 2, pp. 171–187, 2011.
- [22] N. Wettels, V. J. Santos, R. S. Johansson, and G. E. Loeb, "Biomimetic tactile sensor array," *Advanced Robotics*, vol. 22, no. 8, pp. 829–849, 2008.
- [23] M. Wiertelowski, D. Leonardis, D. J. Meyer, M. A. Peshkin, and J. E. Colgate, "A high-fidelity surface-haptic device for texture rendering on bare finger," in *Haptics: Neuroscience, Devices, Modeling, and Applications*. Springer, 2014, pp. 241–248.
- [24] S. Derler, L.-C. Gerhardt, A. Lenz, E. Bertaux, and M. Hadad, "Friction of human skin against smooth and rough glass as a function of the contact pressure," *Tribology International*, vol. 42, no. 11, pp. 1565–1574, 2009.